



OBSTACLE 1

SAUMUR 2016



SAUMUR
ATTELAGE

+ Knock down = 5

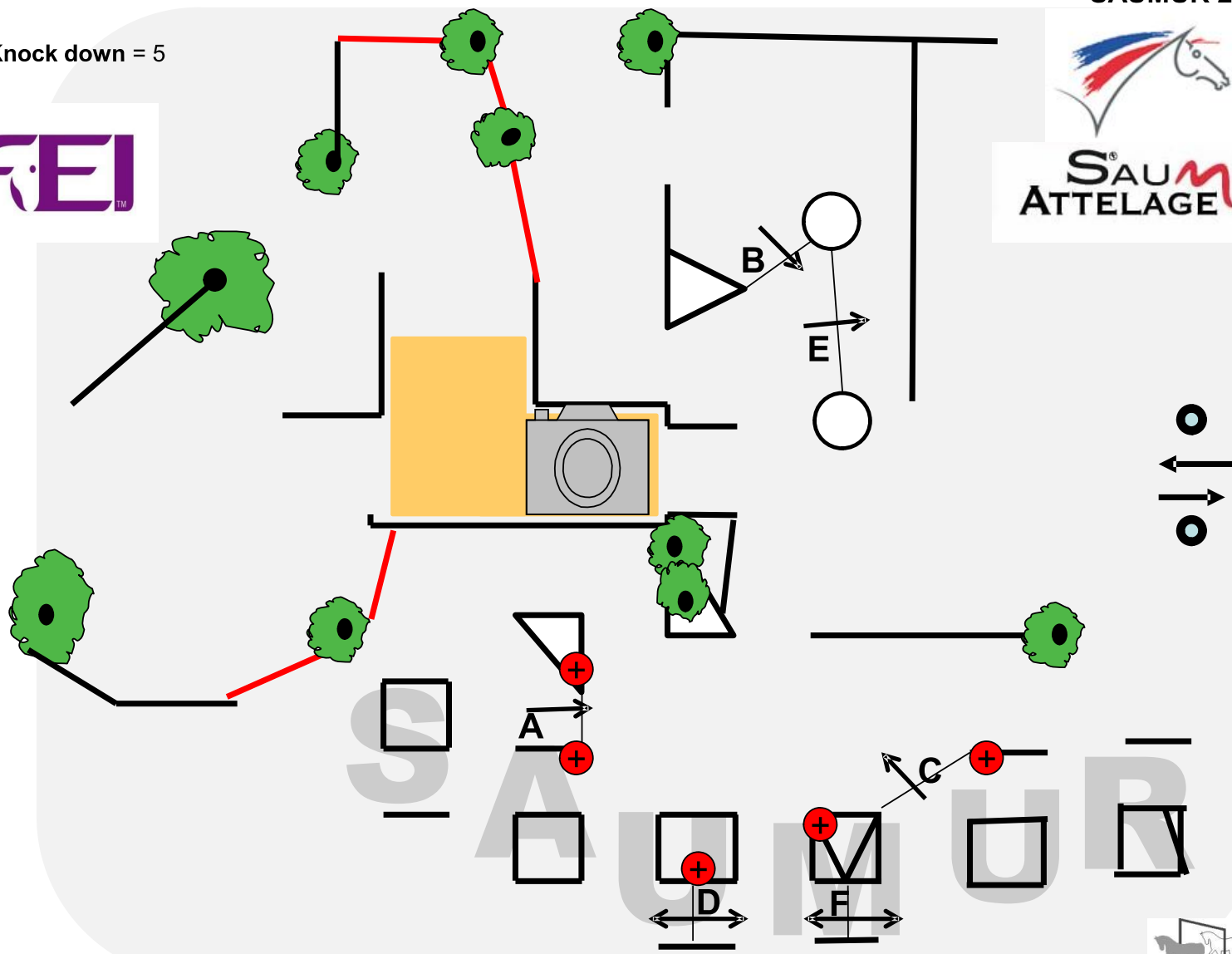

Obstacle N°1 Rampes





OBSTACLE 2

⊕ Knock down = 0



SAUMUR
ATTELAGE

SAUMUR 2016

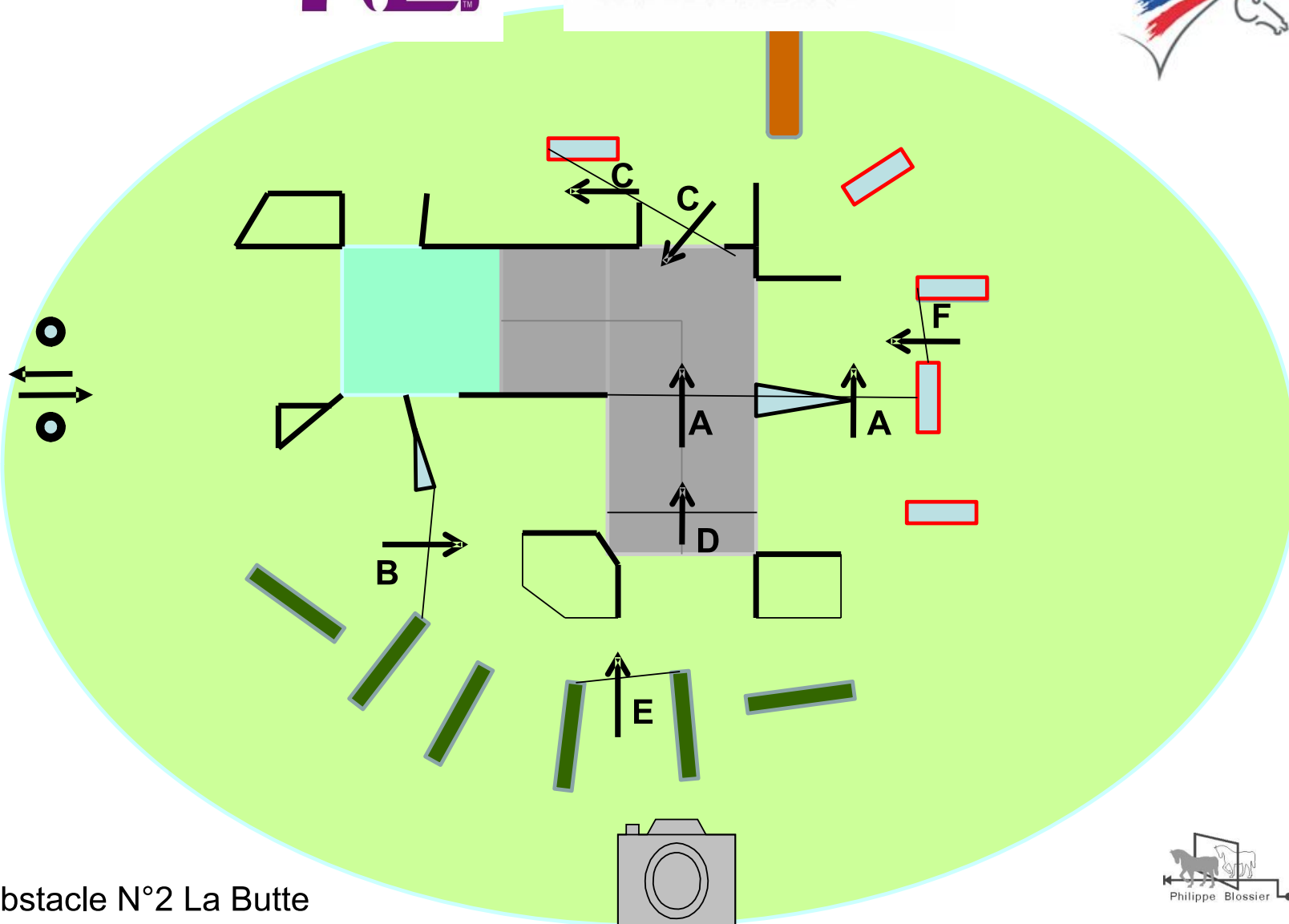

Obstacle N°2 La Butte





OBSTACLE 3

SAUMUR 2016

 Knock down = 5



SAUMUR
ATTELAGÉ

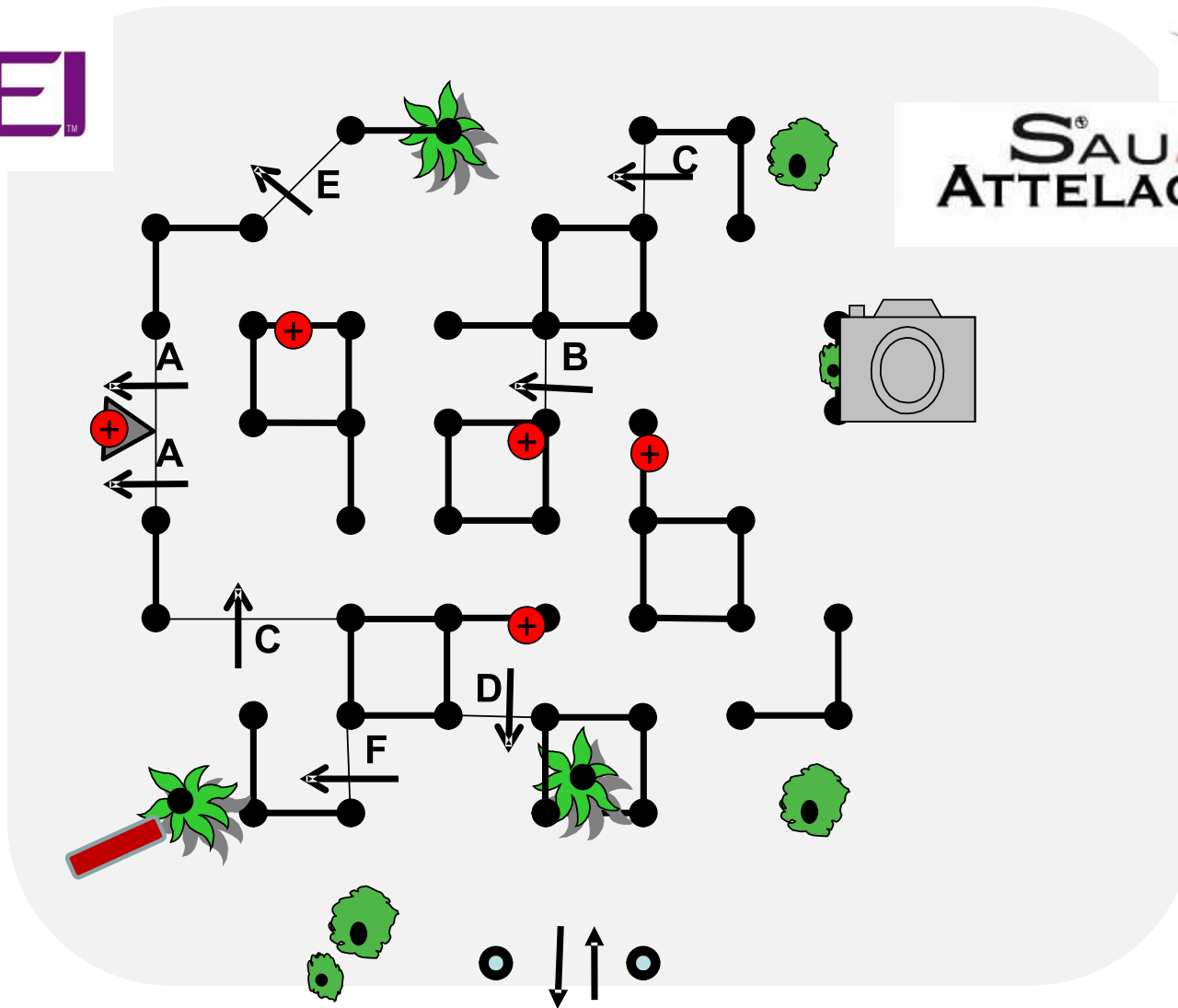

Obstacle N°3 Les Epis





OBSTACLE 4

SAUMUR 2016

 Knock down =5

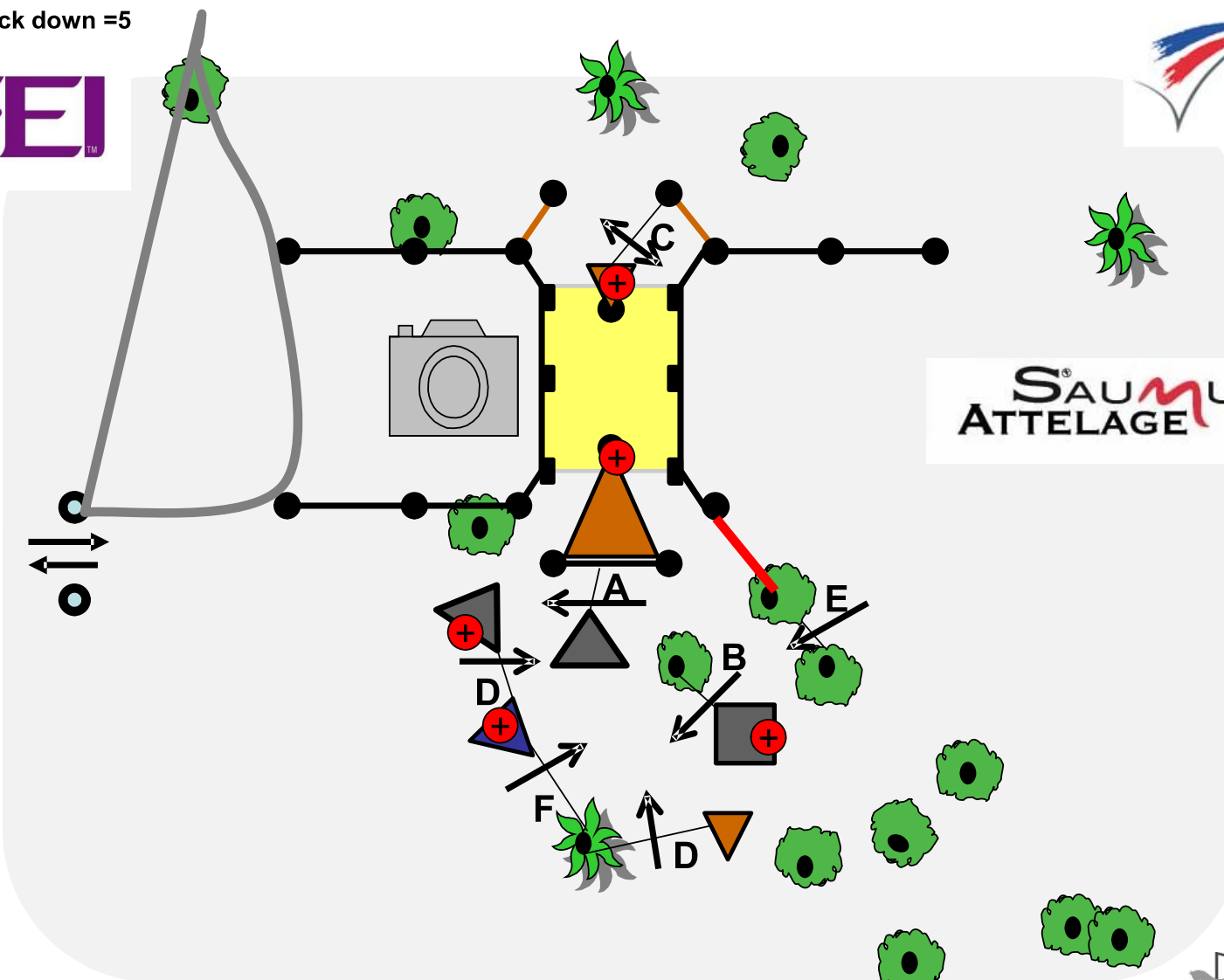

SAUMUR
ATTELAGE

Obstacle N°4 Le Coffin





OBSTACLE 5

SAUMUR 2016

+ Knock down= 5

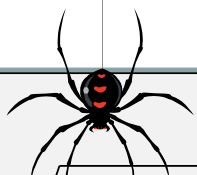

SAUMUR
ATTELAGE

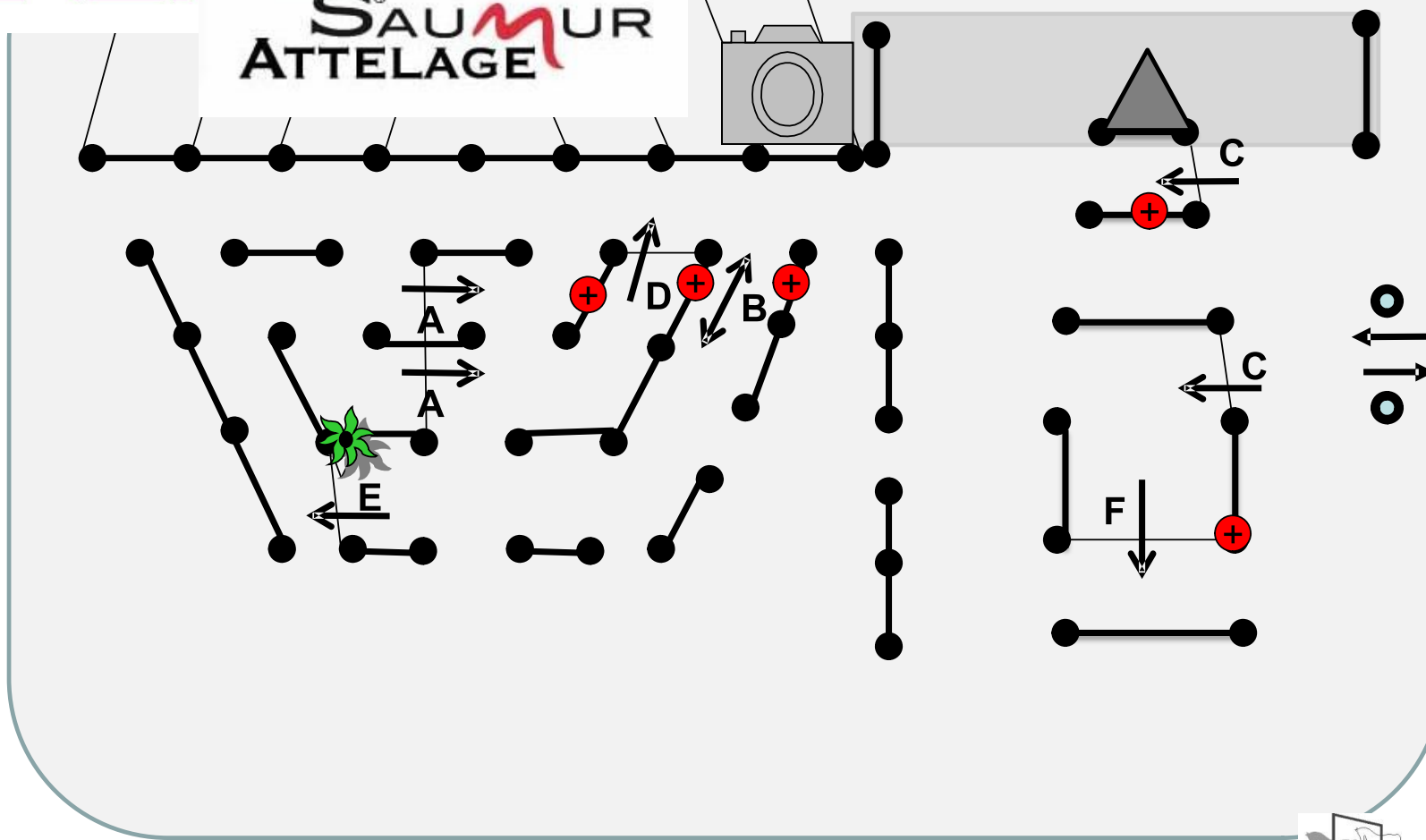
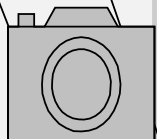

Obstacle N°5 Araignée



OBSTACLE 6

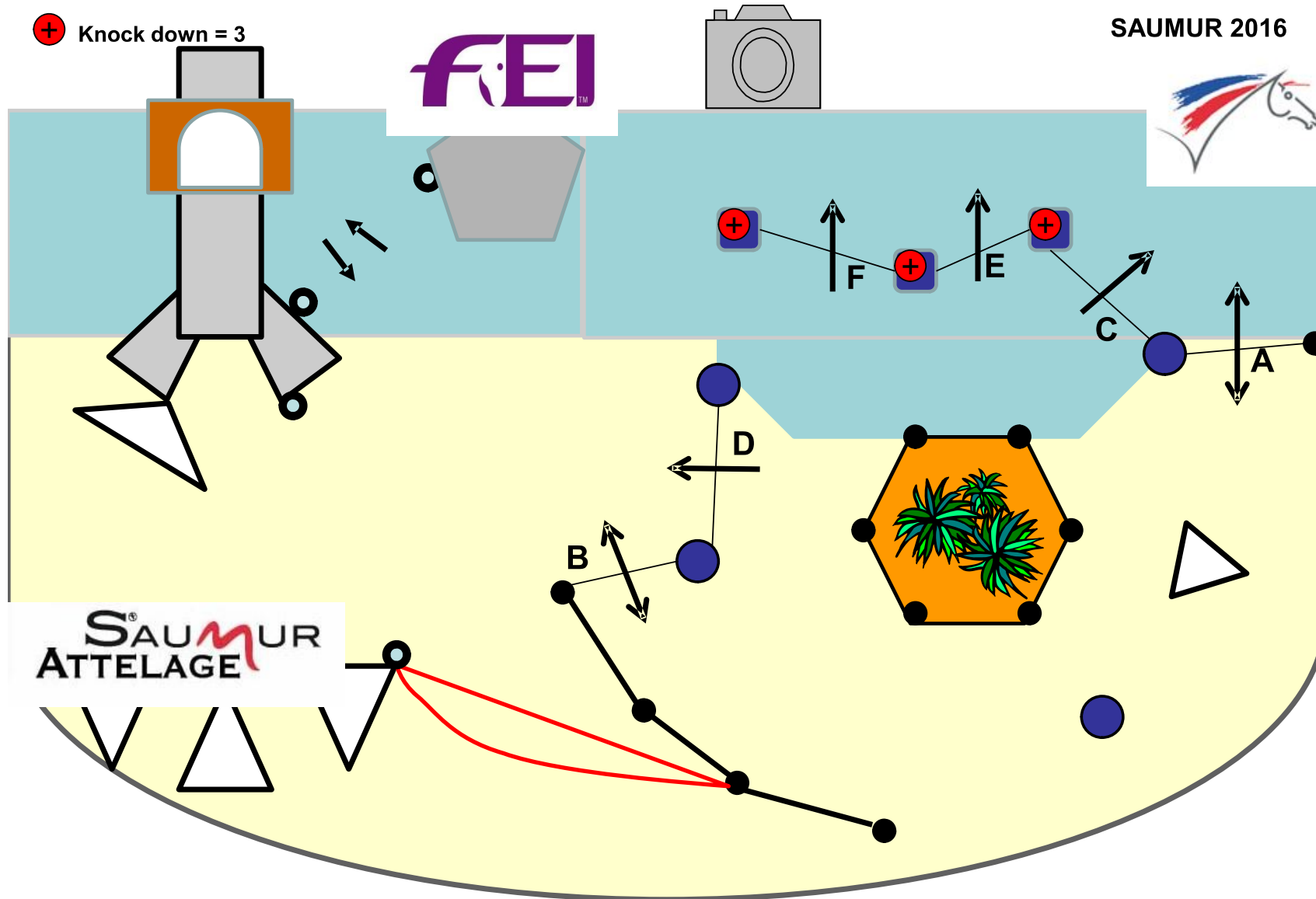

Obstacle N°6 Banque Populaire





OBSTACLE 7

SAUMUR 2016

Knock down = 0



SAUMUR
ATTELAGE

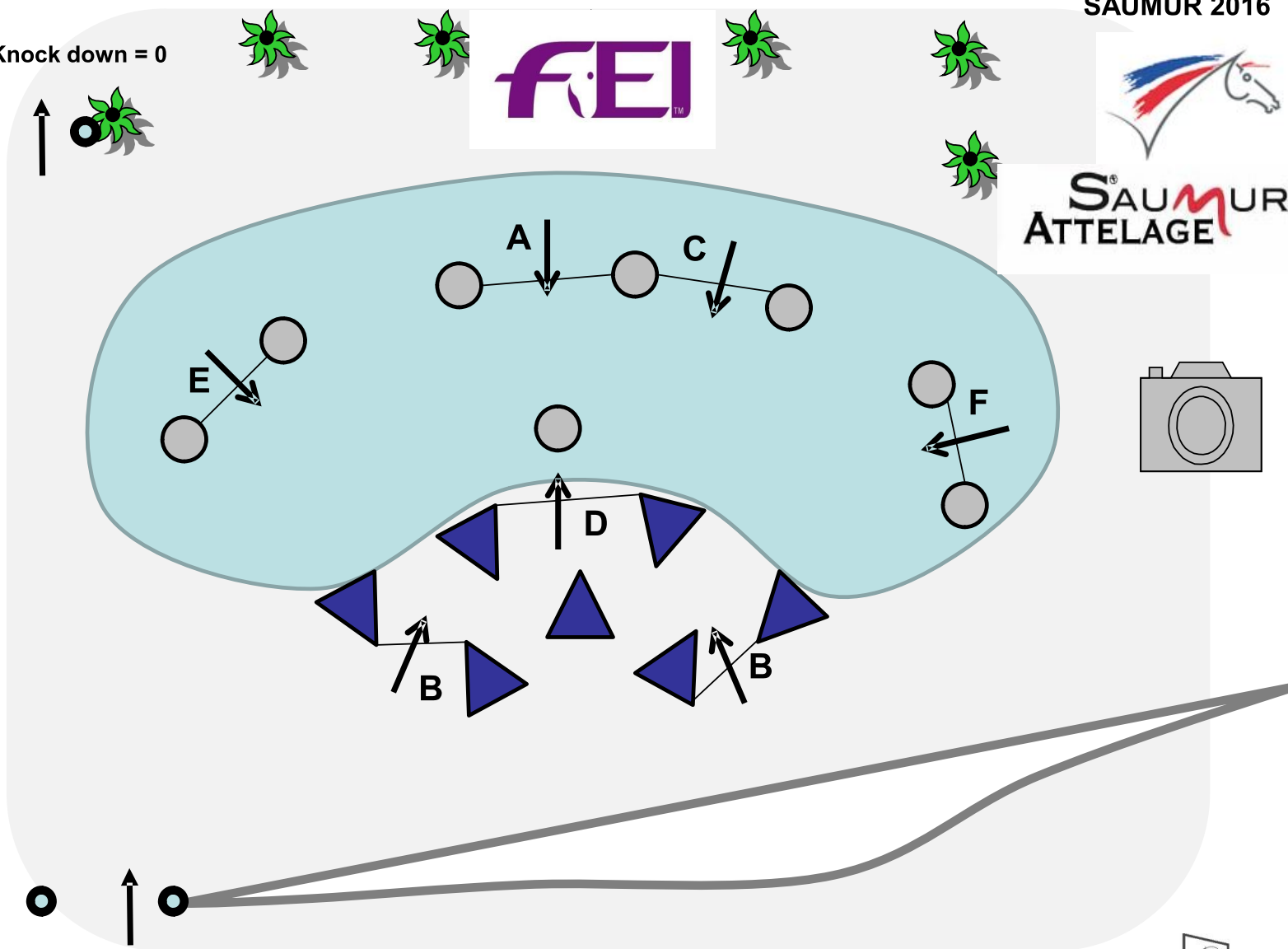
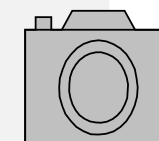

Obstacle N°7 Les Marais



OBSTACLE 8

Knock down =4

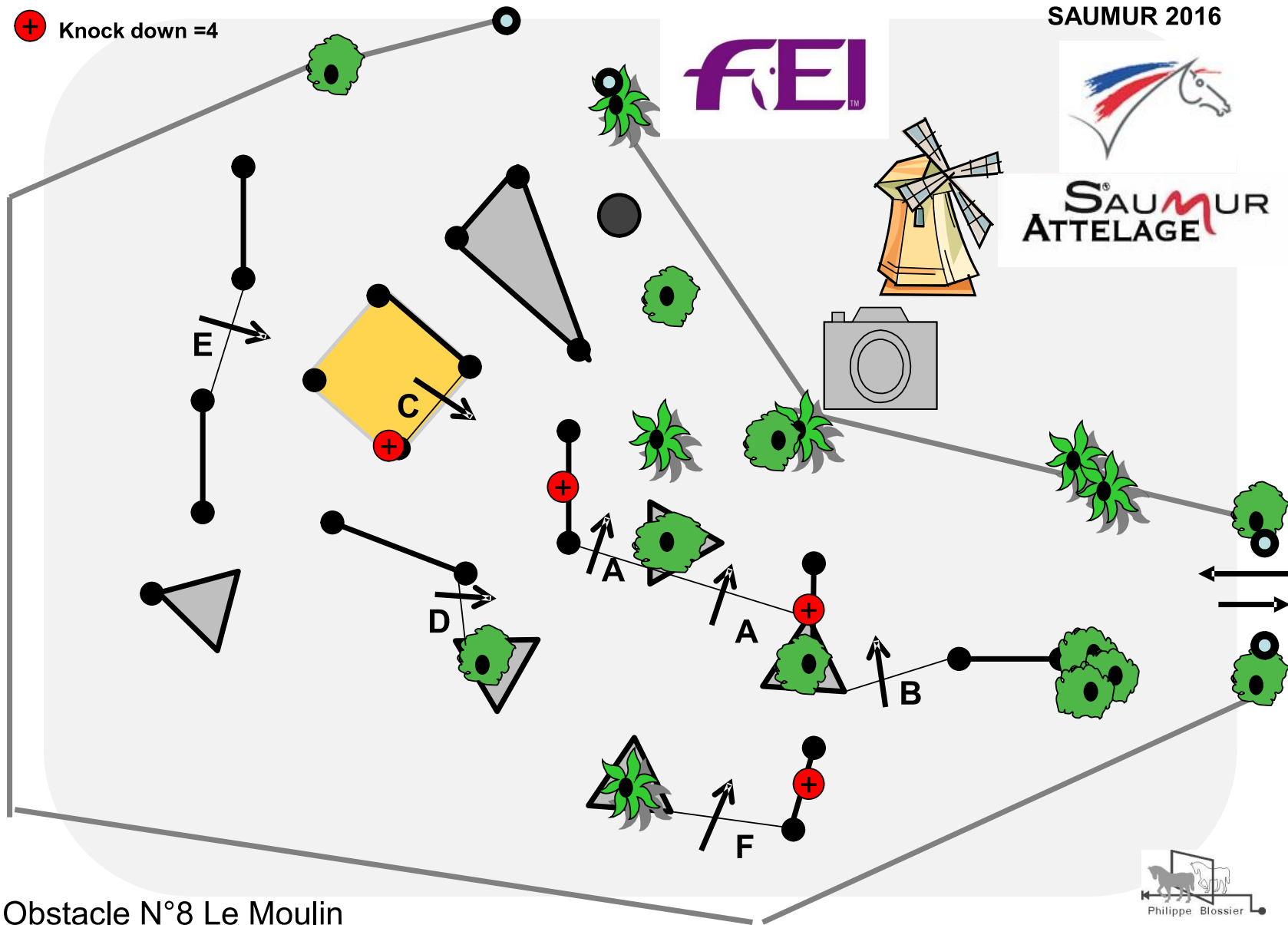

Obstacle N°8 Le Moulin