

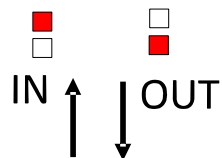

OBSTACLE 1

The Maze
Obstacle 1
A-F
⊗ = 6 x KD

BRITISH[®]
POLO
GIN

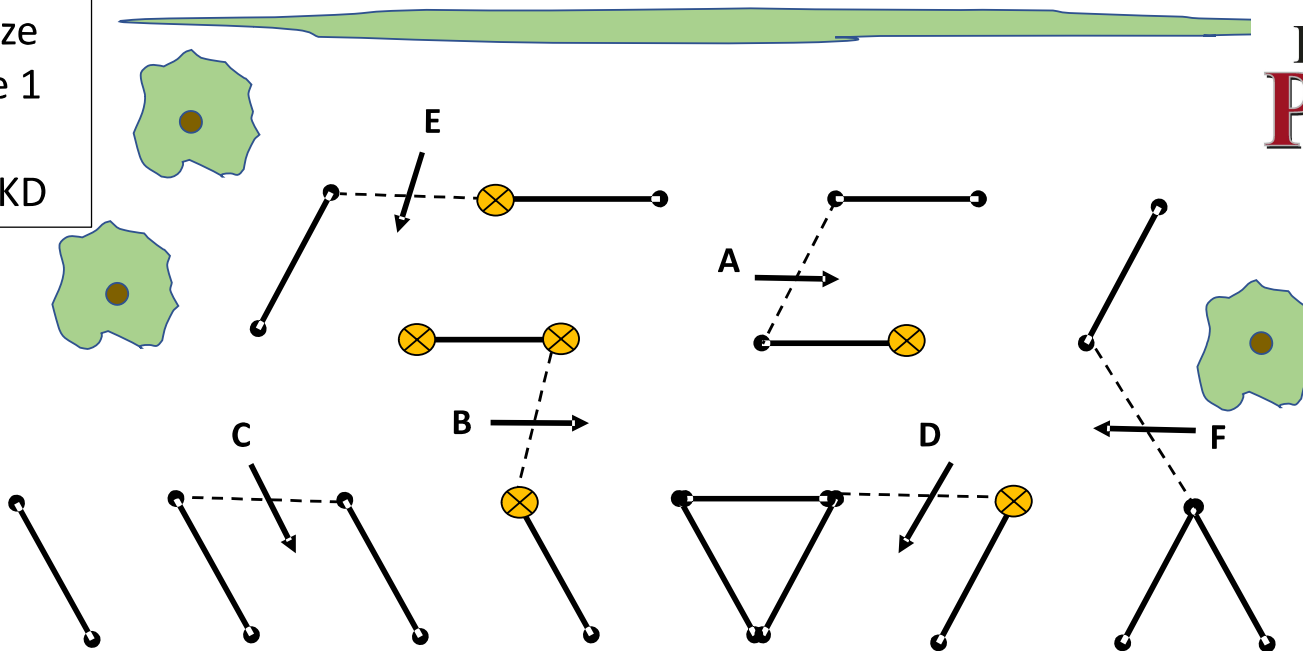



OBSTACLE 2

Arena Saddles
Bank Obstacle 2
A-F
⊗ = 3 x KD

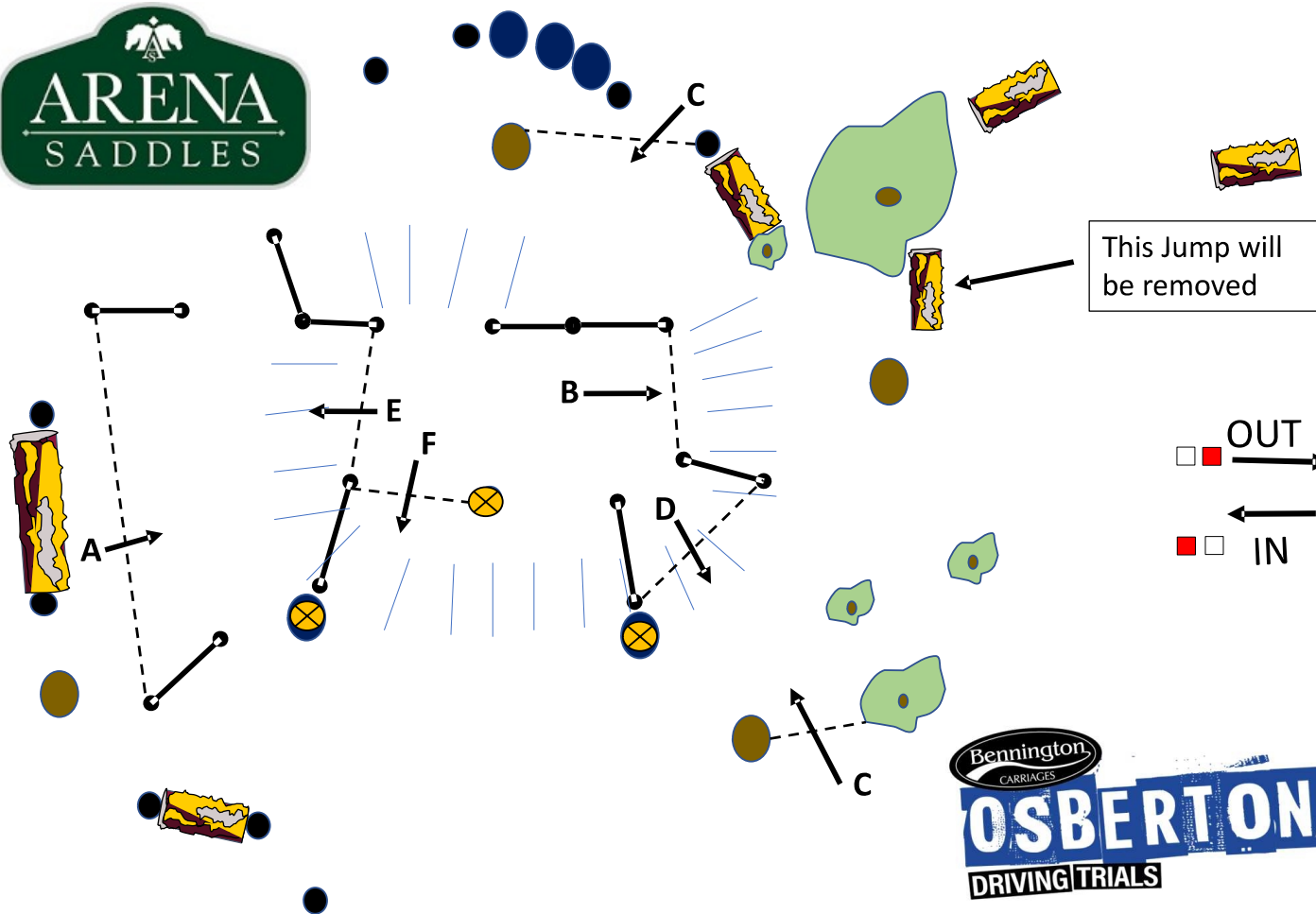



OBSTACLE 4

Equilatte Pond
Obstacle 4
A-F

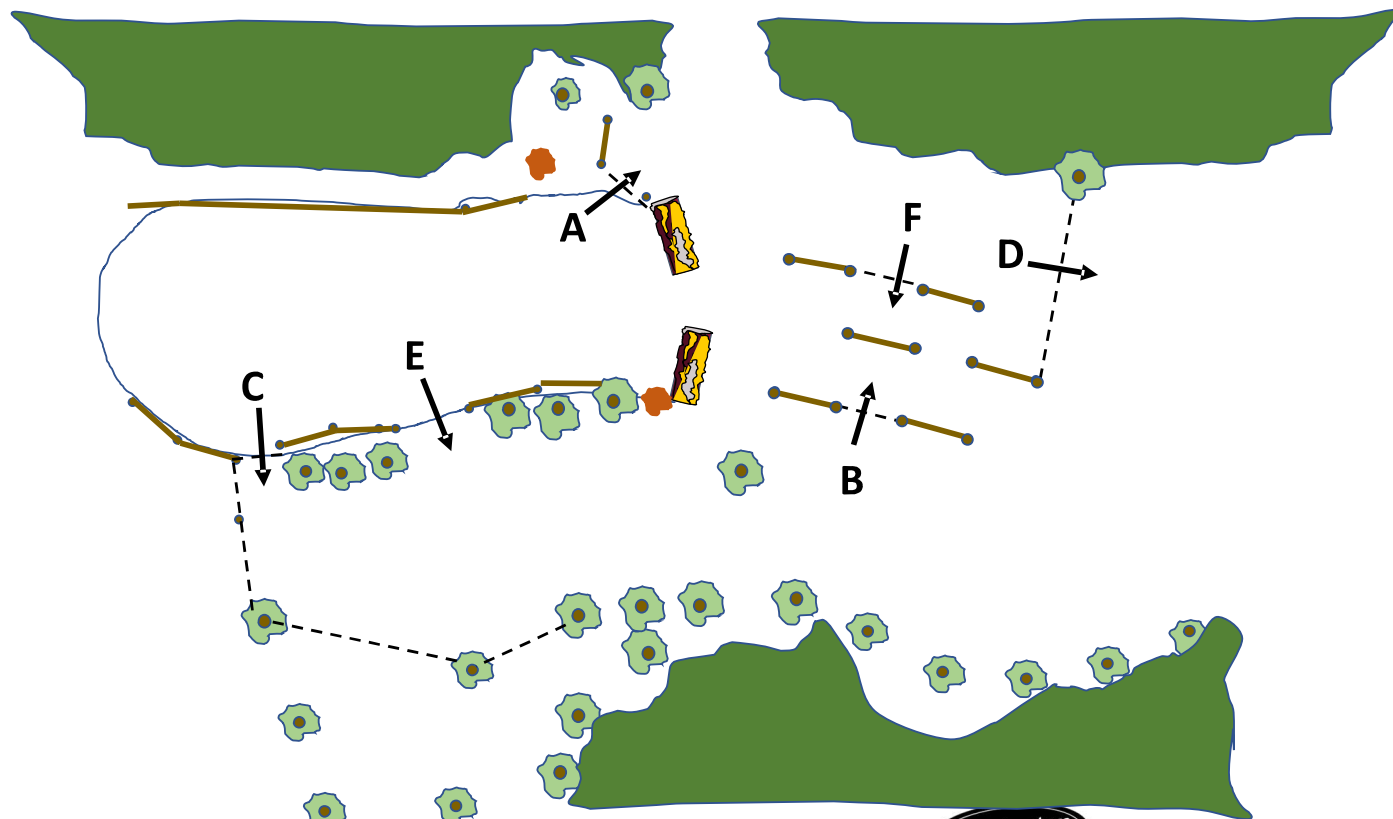
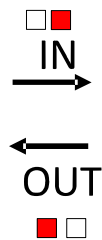



OBSTACLE 5

Bennington Boxes
Obstacle 5 A-F
⊗ = 14 x KD

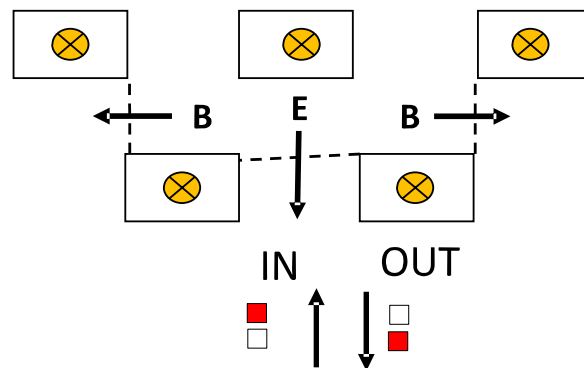
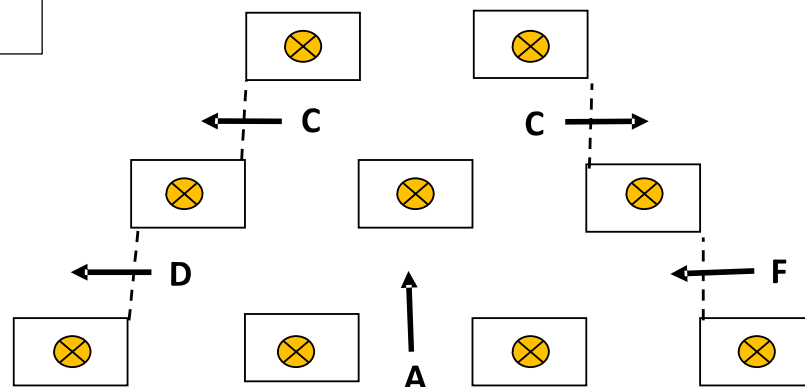



OBSTACLE 6

BEDE Events Portable
Obstacle 6
A-F
⊗ = 12 x KD

