

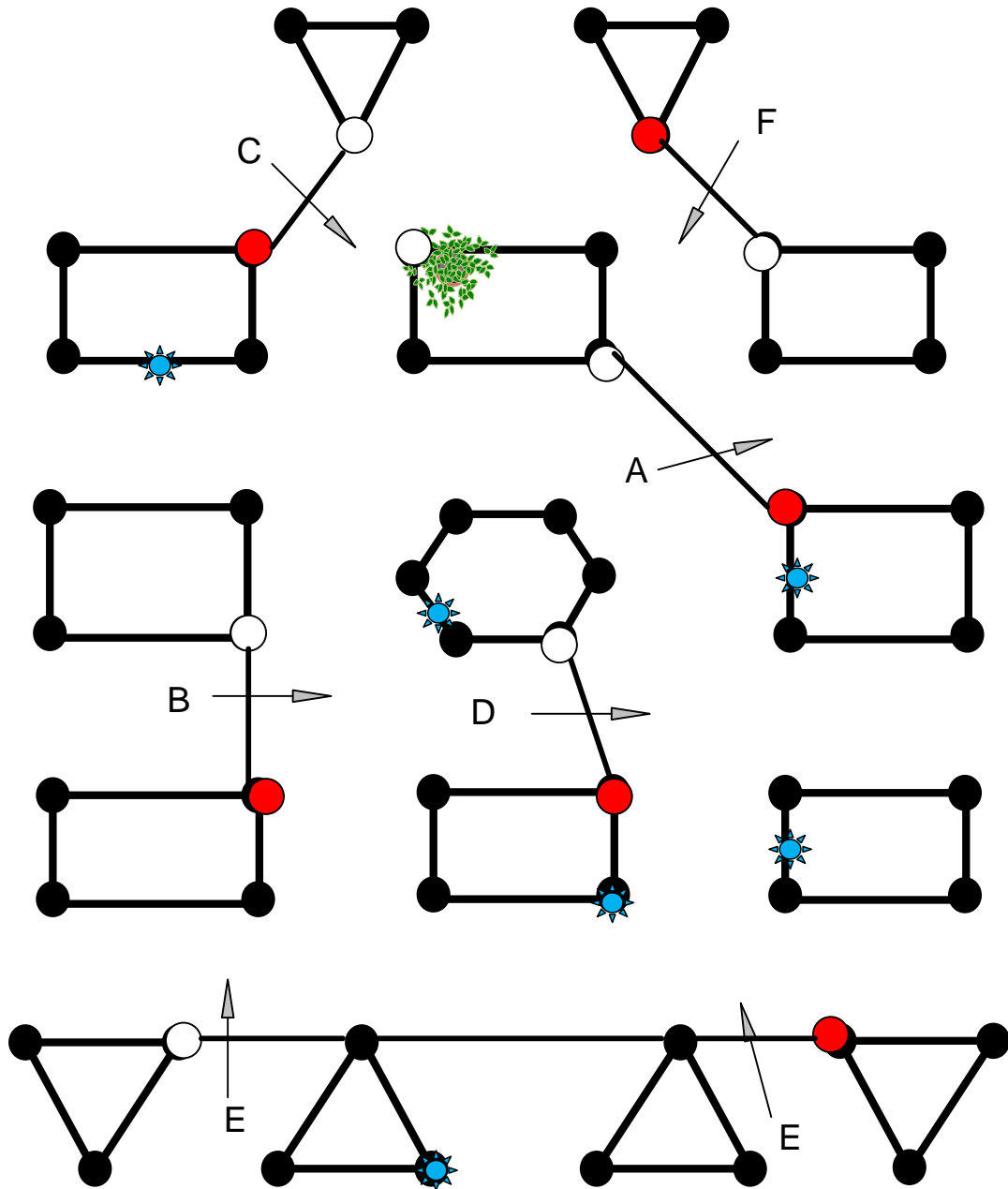

Obstacle 1. Sägewerk Stösser Bühl



Children CAICh: A-D
 6 Knock Downs

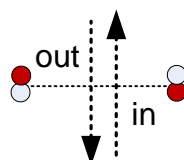

Course Designer
 Henning Lemcke
 Urs Bernhard

Obstacle 2. Sicon Gescher

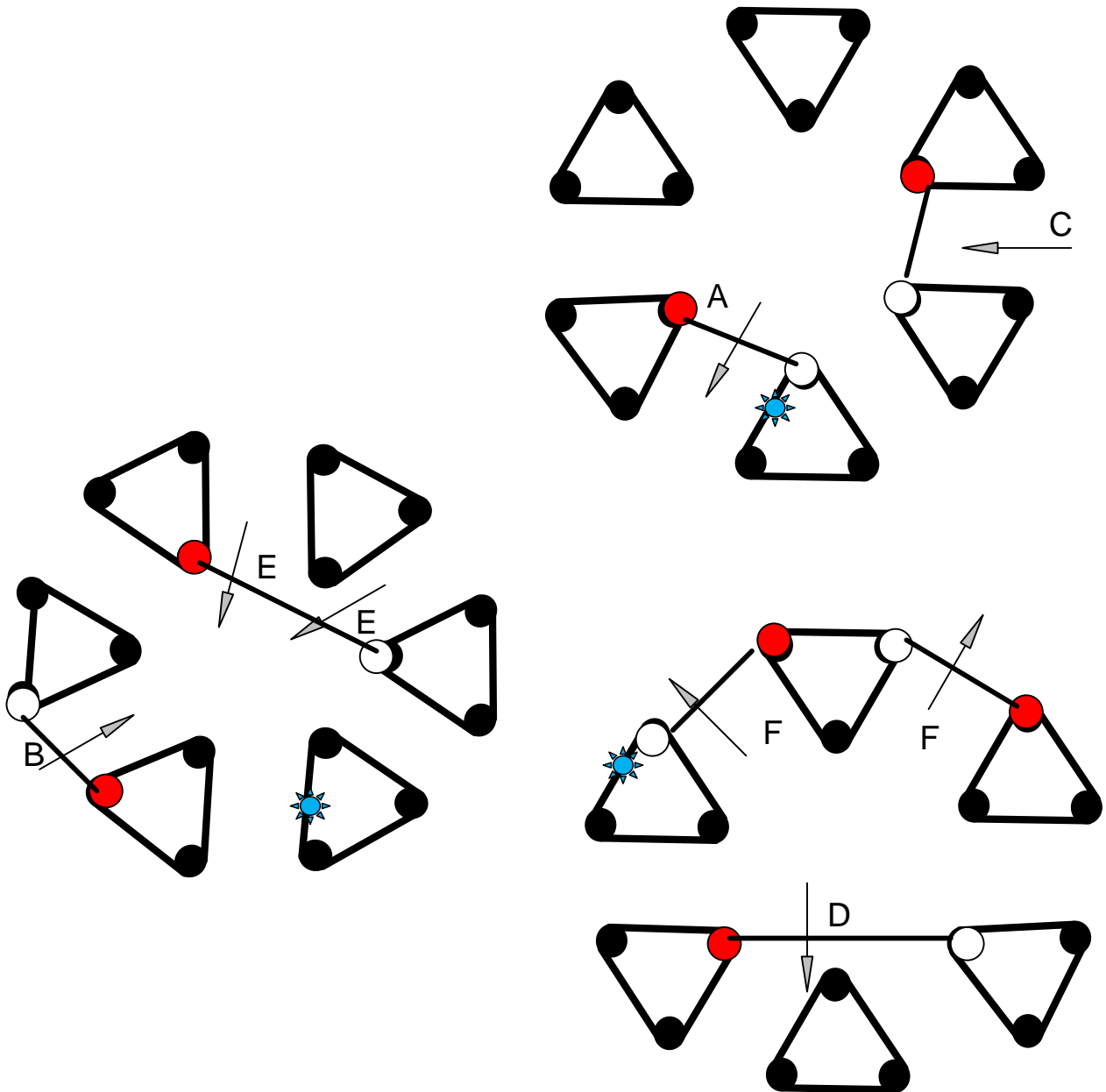

Obstacle 3. Best Wood Kontor

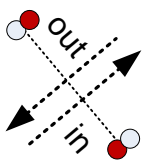
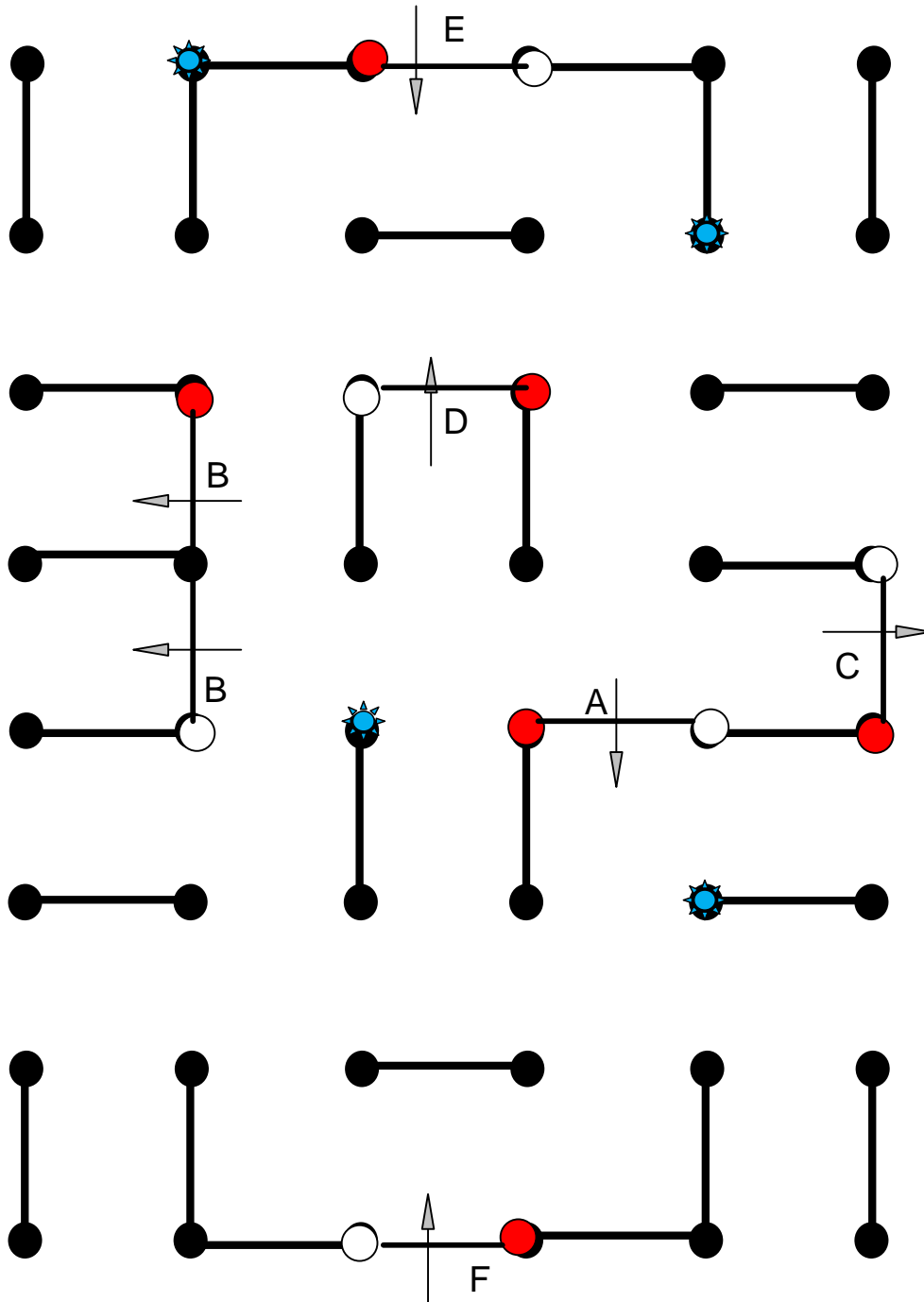

Children CAICh: A-D

4 Knock Downs



Course Designer
 Henning Lemcke
 Urs Bernhard

Obstacle 4. Umweltpartner Vogel AG

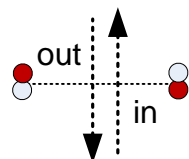
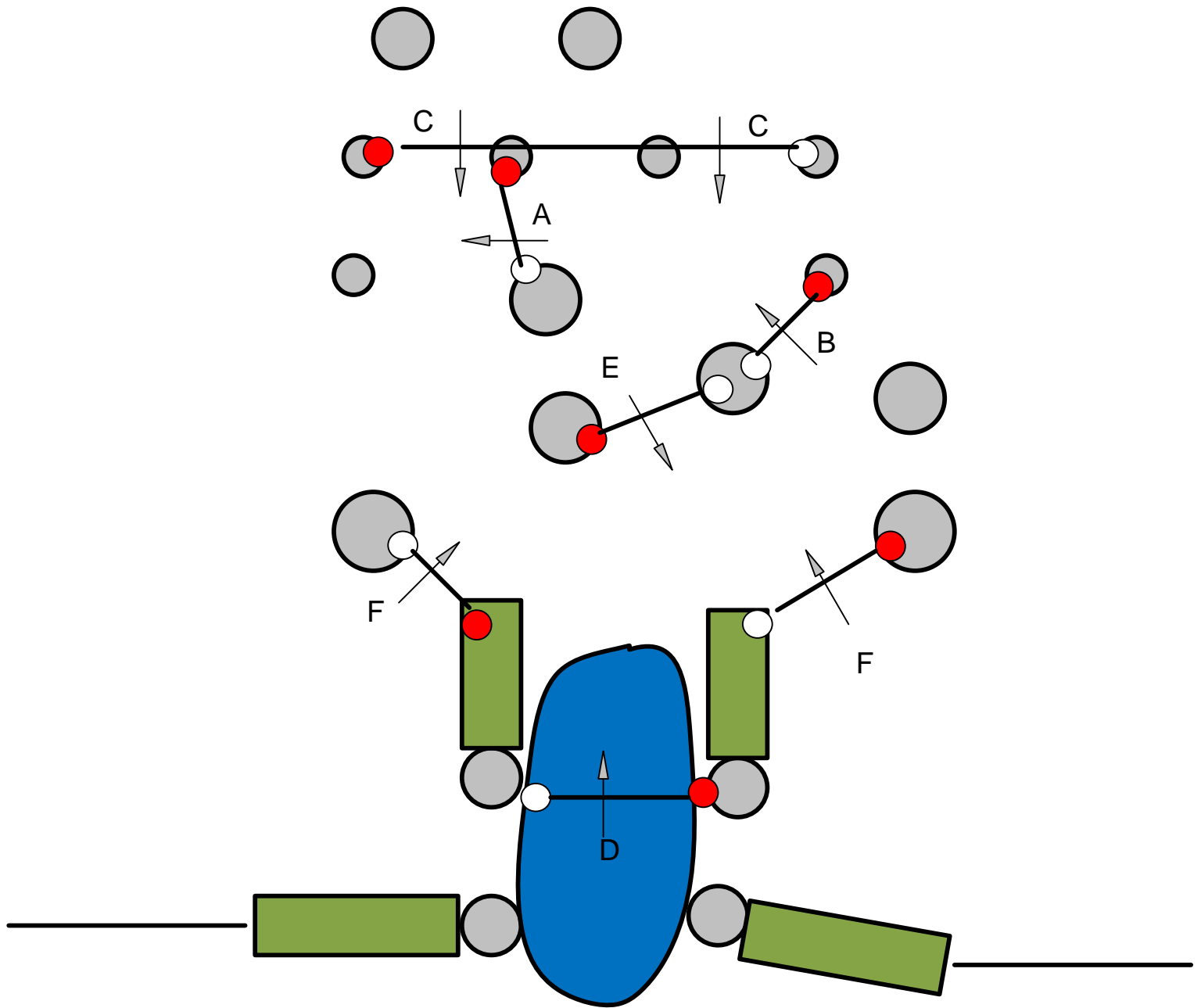

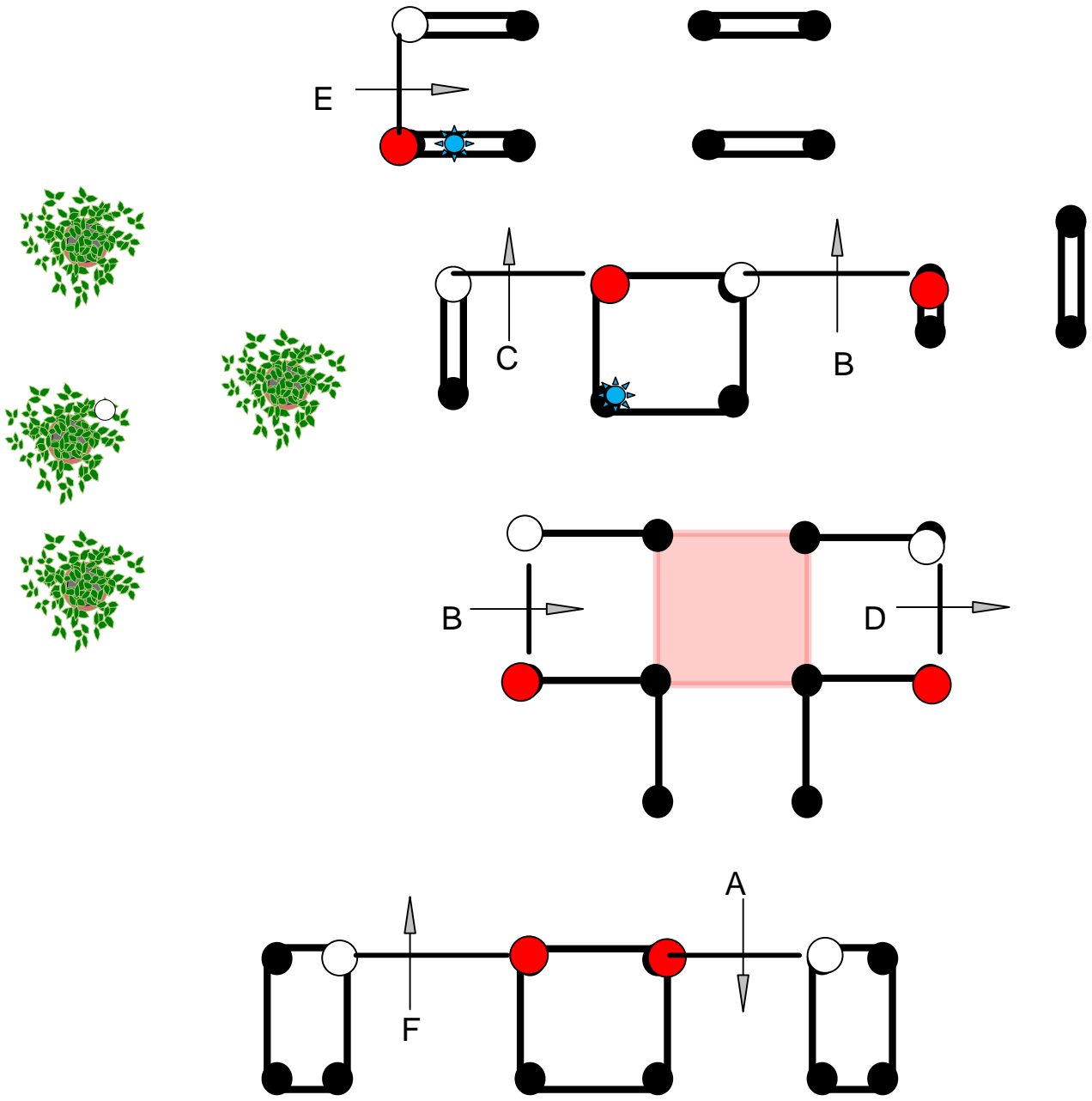

Children CAICh: A-D

Obstacle5. Hopp Schwiz

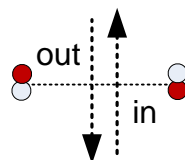

Course Designer
 Henning Lemcke
 Urs Bernhard



Children CAICh: A-D
 2 Knock Downs

Obstacle 6. Sparkasse Bühl

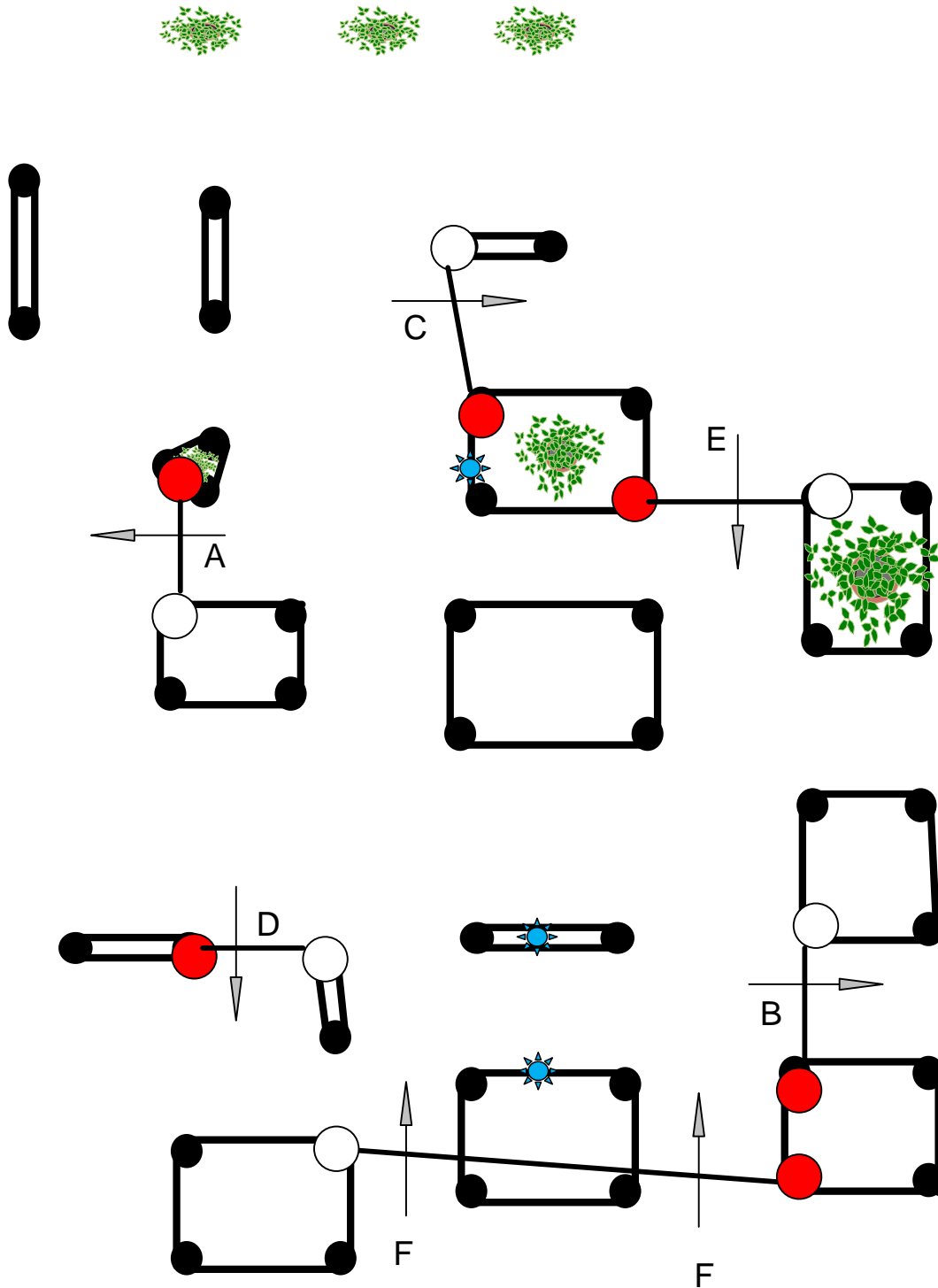

Obstacle 7. Druckerei Stolzenberger

